

Linear

LINI-S XL RGBW Fixture Guide

KKDÖ

Indoor | Surface | RGBW output up to 727lm/m (222lm/ft)



Key applications

- ✓ Architectural detail
- ✓ Mirror back lighting
- ✓ Cove lighting
- ✓ Retail display
- ✓ Direct lighting
- ✓ Shelving display
- ✓ Interior
- ✓ Special effect

Key features

- ✓ Custom lengths
- ✓ Direct view
- ✓ Constant Voltage (CV)
- ✓ IP40 dry area
- ✓ Diffusion: homogenous
- ✓ LEDmix RGBW

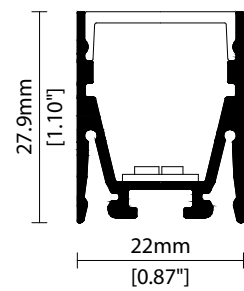

Linear

LINI-S XL RGBW

Specification sheet



Dimensions	H28/W22/L136-2011mm (H1.1/W0.87/L5.35-79.17in)
PCB Cut-point	62.5mm increment/2000mm max (2.46in increment/78.74in max)
LED Pitch	10.4mm-192LED/m (0.41in - 22LED/ft)
Chip	RGBW LEDmix
Cover/Optics	50° (Clear)/120° (Diffused)
CCT	s-line: White: 1900K/2100K/2300K/2500K/2700K/3000K/3500K/4000K/5000K/ RGB: Red 620-625nm/Blue 455-460nm/Green 520-525nm k-line: White: 1900K/2100K/2300K/2500K/2700K/3000K/3500K/4000K/5000K RGB: Red 617-627nm/Blue 464-474nm/Green 515-525nm
LED binning	s-line: White: 2.5-step MacAdam ellipse / RGB: 5nm tolerance k-line: White: 3-step MacAdam ellipse / RGB: 10nm tolerance
CRI	≥ 90 (white only)
Lifetime	50,000 hours @ 25°C (50,000 hours @ 77°F)
Operating temp	T _a = -25 to 50°C (T _c max = 72°C) T _a = -13 to 122°F (T _c max = 162°F)
IP Rating	IP40
Finish	Silver anodised
Mounting	Surface mounting via concealed clips
Power feed	Hardwire tails or male/female connectors
Control	DMX/DALI



LED Grading Key

Exclusive Grade

s s-line*	*KKDC tuned CCT range
2-step CCT range	CCT range

Base Grade

k k-line	3-step commercial range
	Energy Star CCTs

Power consumption	Supply voltage	Supply current
20W/m (6.10W/ft)	24V DC	0.83A/m (0.25A/ft)

	Clear Cover	Diffused Cover
s-line	727lm/m (222lm/ft) 36.4lm/W	505lm/m (154lm/ft) 25.2lm/W
k-line	686lm/m (209lm/ft) 34.3lm/W	476lm/m (145lm/ft) 23.8lm/W

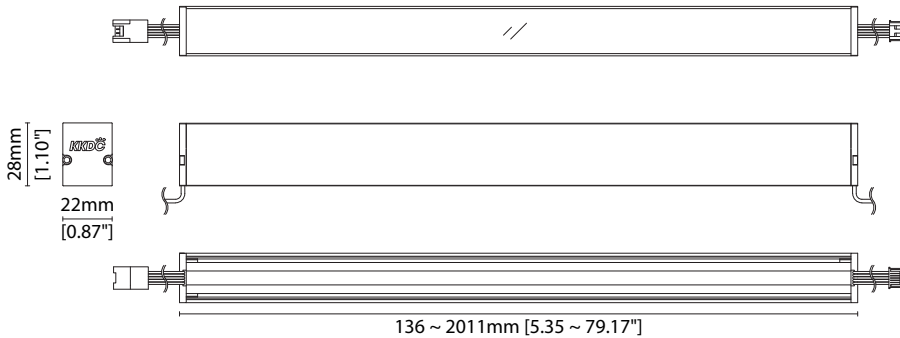

Diffused Cover
 — C0 / C180 cd / 1000 lm --- C90 / C270

Data derived from independent UKAS / IESNA LM-79-08 accredited testing of production samples.

LINE-S XL RGBW

Code Table



FIXTURE

Model	Finish	Cover ¹	Grade ²	LED	Colour (CCT)	Length Availability ³	IP	Cable Length	Power Feed ⁴	Input	
LINE-S XL	Silver Anodised	Clear	B	s	R201	RGB+1900K	m	300mm/ 11.81"	S00X	DC 24V	
					R201	RGB+2100K					136-2011mm 62.5mm increments
		Diffused	C	k	R201	RGB+2300K	i	5.35-79.17in 2.46in increments	1000mm/ 39.37"	D00X	S20X
					R201	RGB+2500K					
					R201	RGB+2700K					
					R201	RGB+3000K					
					R201	RGB+3500K					
					R201	RGB+4000K					
					R201	RGB+5000K					

¹ Refer to **Cover/Lens Options** on **Options** pages

² Refer to LED Grading Key on **Specification sheet** page

³ Refer to **Length Availability List** or enter total run length instead of length code

⁴ Refer to **Power Feed Options** on **Options** pages

Code Example:

SX	-	SA	-	C	-	s	-	R201	-	RGBW	-	35	-	m	511	-	40	-	0300	-	D00X	-	g
LINE-S XL		Silver Anodised		Diffused				R201		RGBW		RGB+3500K		511mm		IP40		300mm/11.81"		Double no sheath tail		DC 24V	

ACCESSORIES

Connection Accessories

KKCN-29	5 PIN RGBW male & female 50mm/1.97" pair
KKCN-30	5 PIN RGBW male & female 300mm/11.81" pair
KKCN-32	5 PIN RGBW 1000mm/39.37" extension lead

PSU/Driver

DALI/DMX
* Refer to Driver/PSU Options page for details or provide requirement and KKDC to offer the suitable option

* Refer to **Power feed** on **Accessories** pages

LED ENGINE VARIANTS (LED STRIP TYPE)

Colour	LED	Lumen/m	Lumen/ft	W/m	W/ft	Spec Doc	Length	Increment
Single CCT	R007	423	129	7	2.13	LINE-S XL R007	94-2011mm/3.71-79.17in	41.7mm/1.64in
	R014	772	235	14	4.27	LINE-S XL R014	94-2011mm/3.71-79.17in	41.7mm/1.64in
	R020	1230	375	20	6.10	LINE-S XL R020	94-2011mm/3.71-79.17in	41.7mm/1.64in
	A040	3080	939	40	12.19	LINE-S XL A040	88.0-1511mm/3.46-59.49in	38.46mm/1.51in
Warm Dim/Dynamic White	R207	423	129	16	4.88	LINE-S XL R207	94-2011mm/3.71-79.17in	41.7mm/1.64in
RGB	501	Red 85	Red 26	15.6	4.75	LINE-S XL RGB	94-2011mm/3.71-79.17in	41.7mm/1.64in
		Green 184	Green 56					
		Blue 30	Blue 9					
		RGB 267	RGB 81					
RGBW	R201	727	222	20	6.10	LINE-S XL RGBW	136-2011mm/5.35-79.17in	62.5mm/2.46in

* Performance data: s-line, diffused cover, 3000K + RGB

LINE-S XL RGBW

Length Availability List



Length Code		Fixture Length ¹		LED Strip ²		End Cap Dimension ³		Wattage (W)	Output (lm)
Metric	Imperial(US)	Metric	Imperial(US)	Metric	Imperial(US)	Metric	Imperial(US)		3000K (Test Data)
m0136	i0005	136mm	5.35in	125mm	4.92in	6mm	0.24in	2.50	86
m0199	i0008	199mm	7.81in	188mm	7.38in	6mm	0.24in	3.75	129
m0261	i0010	261mm	10.28in	250mm	9.84in	6mm	0.24in	5.00	172
m0324	i0013	324mm	12.74in	313mm	12.30in	6mm	0.24in	6.25	214
m0386	i0015	386mm	15.20in	375mm	14.76in	6mm	0.24in	7.50	257
m0449	i0018	449mm	17.66in	438mm	17.22in	6mm	0.24in	8.75	300
m0511	i0020	511mm	20.12in	500mm	19.69in	6mm	0.24in	10.00	343
m0574	i0023	574mm	22.58in	563mm	22.15in	6mm	0.24in	11.25	386
m0636	i0025	636mm	25.04in	625mm	24.61in	6mm	0.24in	12.50	429
m0699	i0028	699mm	27.50in	688mm	27.07in	6mm	0.24in	13.75	472
m0761	i0030	761mm	29.96in	750mm	29.53in	6mm	0.24in	15.00	515
m0824	i0032	824mm	32.42in	813mm	31.99in	6mm	0.24in	16.25	557
m0886	i0035	886mm	34.88in	875mm	34.45in	6mm	0.24in	17.50	600
m0949	i0037	949mm	37.34in	938mm	36.91in	6mm	0.24in	18.75	643
m1011	i0040	1011mm	39.80in	1000mm	39.37in	6mm	0.24in	20.00	686
m1074	i0042	1074mm	42.26in	1063mm	41.83in	6mm	0.24in	21.25	729
m1136	i0045	1136mm	44.72in	1125mm	44.29in	6mm	0.24in	22.50	772
m1199	i0047	1199mm	47.19in	1188mm	46.75in	6mm	0.24in	23.75	815
m1261	i0050	1261mm	49.65in	1250mm	49.21in	6mm	0.24in	25.00	858
m1324	i0052	1324mm	52.11in	1313mm	51.67in	6mm	0.24in	26.25	900
m1386	i0055	1386mm	54.57in	1375mm	54.13in	6mm	0.24in	27.50	943
m1449	i0057	1449mm	57.03in	1438mm	56.59in	6mm	0.24in	28.75	986
m1511	i0059	1511mm	59.49in	1500mm	59.06in	6mm	0.24in	20.00	686
m1574	i0062	1574mm	61.95in	1563mm	61.52in	6mm	0.24in	31.25	1072
m1636	i0064	1636mm	64.41in	1625mm	63.98in	6mm	0.24in	32.50	1115
m1699	i0067	1699mm	66.87in	1688mm	66.44in	6mm	0.24in	33.75	1158
m1761	i0069	1761mm	69.33in	1750mm	68.90in	6mm	0.24in	35.00	1201
m1824	i0072	1824mm	71.79in	1813mm	71.36in	6mm	0.24in	36.25	1243
m1886	i0074	1886mm	74.25in	1875mm	73.82in	6mm	0.24in	37.50	1286
m1949	i0077	1949mm	76.71in	1938mm	76.28in	6mm	0.24in	38.75	1329
m2011	i0079	2011mm	79.17in	2000mm	78.74in	6mm	0.24in	40.00	1372

¹ Actual total overall length of light fixture (LED strip + end caps + void/wire hole)

² Actual length of PCB strip

³ Actual length of 2x end caps

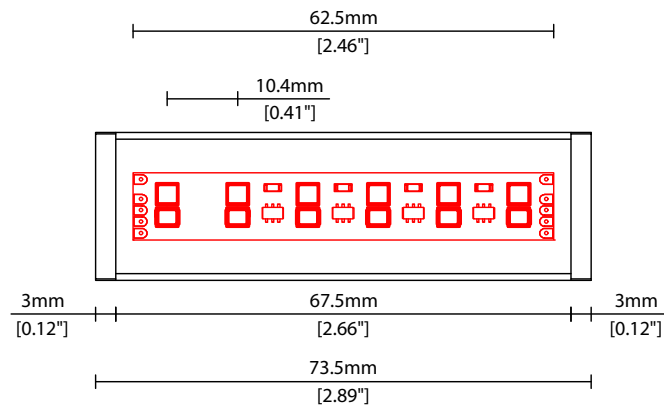

Linear

LINI-S XL RGBW Options

KKDC

COVER/LENS OPTIONS

* Options are an integral part of the fixture ordering codes. Please refer to **Code Table** pages.



B Clear cover

W22/H27.9mm (W0.87/H1.10")

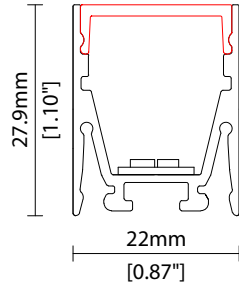

C Diffused cover

W22/H27.9mm (W0.87/H1.10")

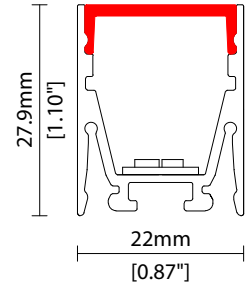

POWER FEED OPTIONS

* Options are an integral part of the fixture ordering codes. Please refer to **Code Table** pages.

0300 S00X 300mm (11.81") Single no sheath tail

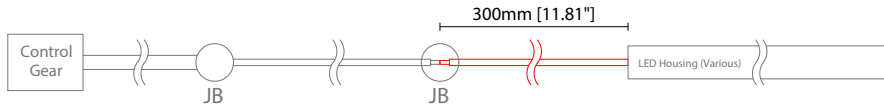

0300 D00X 300mm (11.81") Double no sheath tail

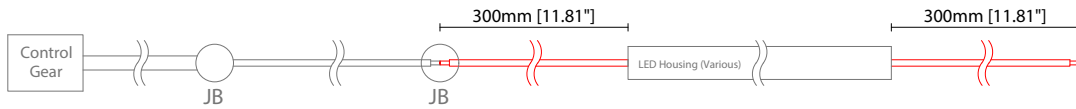

0300 S20X 300mm (11.81") Single no sheath IP20 connector

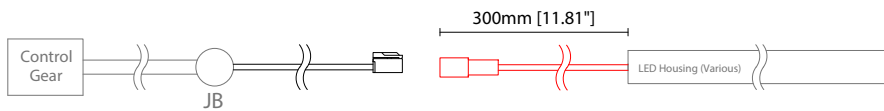

0300 D20X 300mm (11.81") Double no sheath IP20 connector

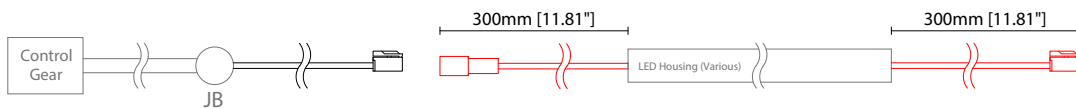

1000 S00X 1000mm (39.37") Single no sheath tail

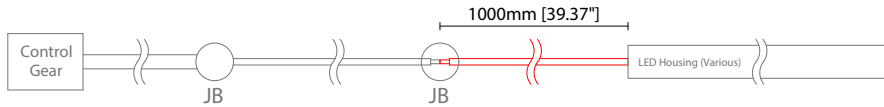

1000 D00X 1000mm (39.37") Double no sheath tail

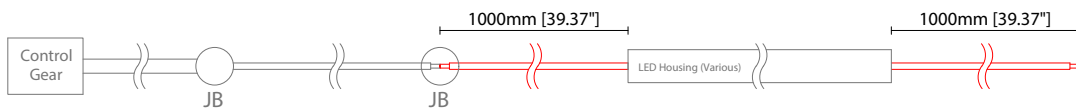

1000 S20X 1000mm (39.37") Single no sheath IP20 connector

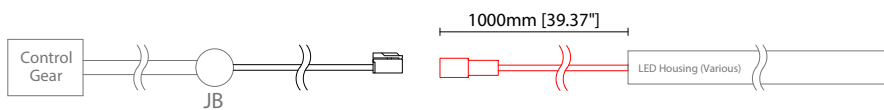

1000 D20X 1000mm (39.37") Double no sheath IP20 connector

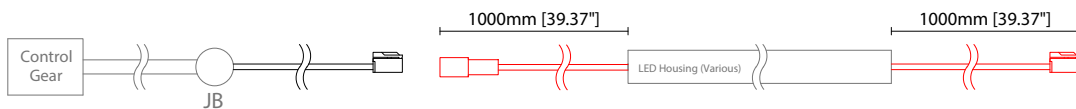

Key

Control Gear Power supply, sub-controllers & control systems

JB Junction box / cable connection

Linear

LINI-S XL RGBW Options



POWER FEED OPTIONS (CONTINUED)

5 Pin RGBW Female Connector

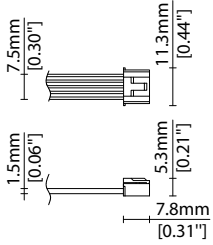

5 Pin RGBW Male Connector

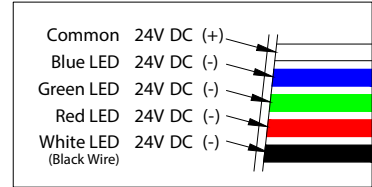
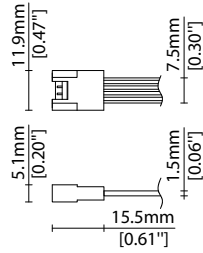

MOUNTING ACCESSORIES

Note: Accessories are to be ordered separately with corresponding code shown below.



KKCP-11
Concealed clip
(allow 3 per metre/40in)
S/Steel finish
L20/W22/H28.1mm
(L0.79/W0.87/H1.11")

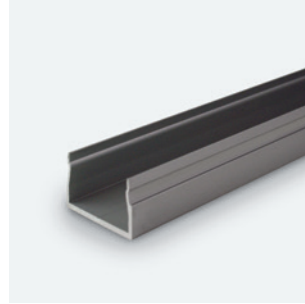
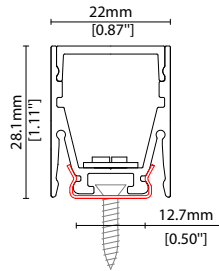

KKCR-01-1000 1000mm (39.37in)
KKCR-01-2000 2000mm (78.74in)
KKCR-01-3000 3000mm (118.11in)
Cable raceway*
anodised aluminium finish
W22/H36.4mm (W0.87/H1.43")
* Cut & drilled to fit on site

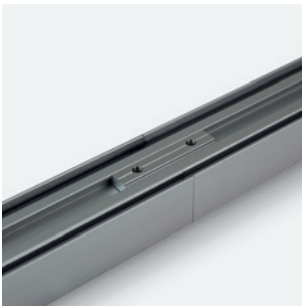
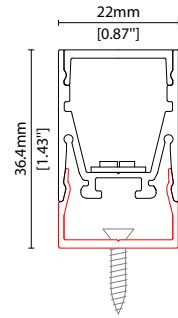

KKJT-02
Joining bar* (allow 1 per join)
anodised aluminium finish
L25mm (L0.98")
* Mounting option required with
Joining bar

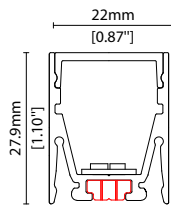

POWER FEED

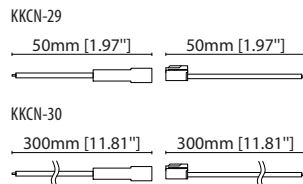

KKCN-29 50mm (1.97in) pair
KKCN-30 300mm (11.81in) pair
5-PIN RGBW male + female
connector set

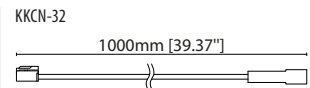

KKCN-32 1000mm (39.37in) pair
5-PIN RGBW male + female
extension lead

KKDC CONTROL



IP20
Plastic housing
L170/W59/H29mm
(L6.69/W2.32/H1.14in)

KKDM-06 1-10V

visDIM dimmable sub-controller
(4 x 8A max @ 12-36V)



IP20
Plastic housing
L170/W53.4/H28mm
(L6.69/W2.10/H1.10in)

KKSC-05 DMX

visDIM dimmable sub-controller
(4 x 5A max @ 12-36V)



IP20
Plastic housing
L170/W59/H29mm
(L6.69/W2.32/H1.14in)

KKDL-02 DALI

visDIM dimmable sub-controller
(4 x 8A max @ 12-36V)



IP20
Plastic housing
L166/W53.4/H23mm
(L6.54/W2.10/H0.91in)

KKDL-03 DALI

visDIM dimmable sub-controller
(4 x 5A max @ 12-36V)

AVAILABLE PSU OPTIONS

Control Mode	PSU (Order Code)	Input Voltage AC	Output Voltage DC	Rated Output Current	Rated Power	Dim %	IP Rating
Switched	CEN-60-24	90-295V	24V	2.5A	60W	-	IP67
	HLG-60H-24	90-305V	24V	2.5A	60W	-	IP67
	HLG-100H-24	90-305V	24V	4.0A	100W	-	IP67
	HLG-150H-24	90-305V	24V	6.3A	150W	-	IP67
	HLG-240H-24	90-305V	24V	10A	240W	-	IP67
0-10V (1-10V)	PWM-40-24	90-305V	24V	1.67A	40W	100-0.15 (100-10)	IP67
	PWM-60-24	90-305V	24V	2.5A	60W	100-0.15 (100-10)	IP67
	PWM-90-24	90-305V	24V	3.67A	90W	100-0.15 (100-10)	IP67
	PWM-120-24	90-305V	24V	5.0A	120W	100-0.15 (100-10)	IP67
DALI	LIN100A1	120-277V	24V	1A per channel	100W	100-0.1	IP66/IP40
DMX RGB	LIN100A1	120-277V	24V	1.33A per channel	100W	100-0.1	IP66/IP40
DMX RGBW	LIN100A1	120-277A	24V	1A per channel	100W	100-0.1	IP66/IP40

Flicker Free Options - Combination of PSU+ sub-controller

Control Mode	PSU (Order Code)	Sub-controller (Order Code)	Input Voltage AC	Output Voltage DC	Rated Output Current	Rated Power	Dim %	IP Rating PSU/ Sub-controller
0-10V or 1-10V	CEN-60-24	KKDM-06	90-295V	24V	2.5A	60W	100-0.9	IP67/IP20
	HLG-60H-24	KKDM-06	90-295V	24V	2.5A	60W	100-0.9	IP67/IP20
	HLG-100H-24	KKDM-06	90-295V	24V	4.0A	100W	100-0.9	IP67/IP20
	HLG-150H-24	KKDM-06	90-295V	24V	6.3A	150W	100-0.9	IP67/IP20
	HLG-240H-24	KKDM-06	90-295V	24V	10.0A	240W	100-0.9	IP67/IP20
DALI	CEN-60-24	KKDL-02/03	90-295V	24V	2.5A	60W	100-0.1	IP67/IP20
	HLG-60H-24	KKDL-02/03	90-305V	24V	2.5A	60W	100-0.1	IP67/IP20
	HLG-100H-24	KKDL-02/03	90-305V	24V	4.0A	100W	100-0.1	IP67/IP20
	HLG-150H-24	KKDL-02/03	90-305V	24V	6.3A	150W	100-0.1	IP67/IP20
	HLG-240H-24	KKDL-02/03	90-305V	24V	10.0A	240W	100-0.1	IP67/IP20
DMX RGB	CEN-60-24	KKSC-05	90-295V	24V	2.5A	60W	100-0.9	IP67/IP20
	HLG-60H-24	KKSC-05	90-305V	24V	2.5A	60W	100-0.9	IP67/IP20
	HLG-100H-24	KKSC-05	90-305V	24V	4A	100W	100-0.9	IP67/IP20
	HLG-150H-24	KKSC-05	90-305V	24V	6.3A	150W	100-0.9	IP67/IP20
	HLG-240H-24	KKSC-05	90-305V	24V	10.0A	240W	100-0.9	IP67/IP20

¹ The items shown above cover the most frequently used specification but does not exhaust the possible options

² PSU and/or driver can be chosen from the table, or KKDC may recommend the best option upon receipt of the controls requirement and installation environment

³ Electrical shop drawing will include detailed information of PSU and relevant control drivers

⁴ Cut sheets are available on the controls section of www.kkdc.lighting or upon request